

CUSTOMER REFERENCE DRAWING

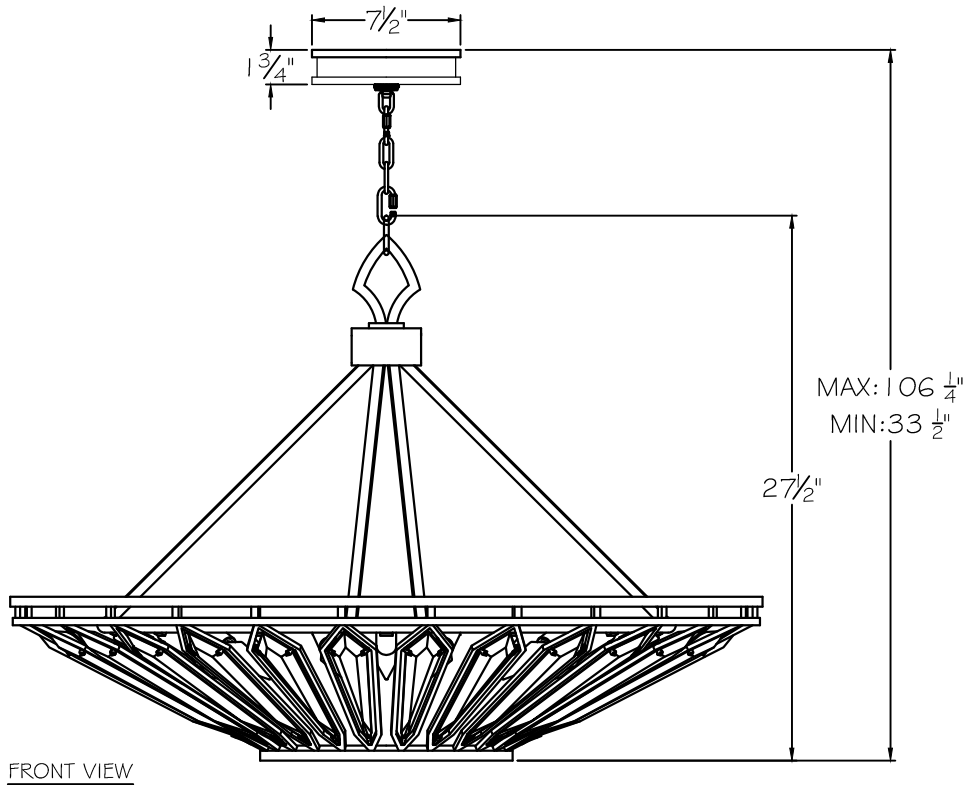
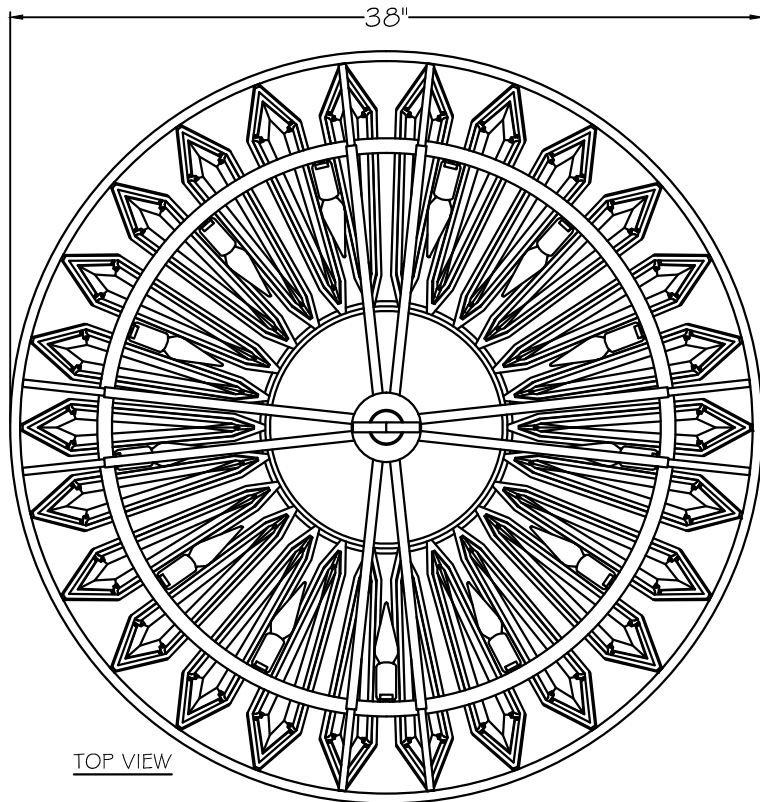

STYLE CONFIGURATIONS:

-1ST (GRAY/SILVER)

-2ST (BROWN/GOLD)

FINE
ART
LAMPS®
EST. 1940

This drawing, specifications and the product depicted are the exclusive property of FINE ART LAMPS®. In compliance with US copyright and patent requirements, notice is hereby given that this document and the product depicted shall not be copied, altered or used in any manner without the expressed written consent of FINE ART LAMPS®.

www.fineartlamps.com
Tel:(305) 821-3850 Fax:(305) 821-1564

STYLE NUMBER:

885440

DATE:

1/17/2017