

## CAFE 14 INCH STRAIGHT ARM WALL LIGHT

GNN107

### FEATURES + BENEFITS

- Metal RLM shades are spun from heavy duty aluminum.
- Polyester powder coat finish provides color retention and scratch resistance.
- White powder coat shade interior for maximum light output.
- Painted Galvanized finish has Painted Galvanized shade interior.
- Dimmable with a dimmable bulb and compatible dimmer (not included).
- UL Listed for Wet Location.
- Warranty: Limited 1 Year.
- Made in USA.



### SPECIFICATIONS

**Product Dimensions:**

Width 14", Height 14 3/4", Depth 17", Canopy Dia. 4 5/8"

**Lamping:**

100W Medium Base per socket

**Options:**

- Finish: 40-Slate Gray, 41-Black, 42-Forest Green, 44-White Gloss, 48-Sea Green, 49-Painted Galvanized, 50-Navy, 51-Architectural Bronze, 54-Light Blue, 55-Barn Red
- Integrated LED: L13-15W, 1250 Lumen, 95CRI, Adjustable CCT.
- Other Accessories: B01-Decorative Backplate Cover, G05-Clear Weathertight Glass and Guard, W14-Wire Grill

**Shipping:**

At Montclair Light Works we proudly manufacture, assemble, and ship your lamp within 3 weeks from our factory in Montclair CA.

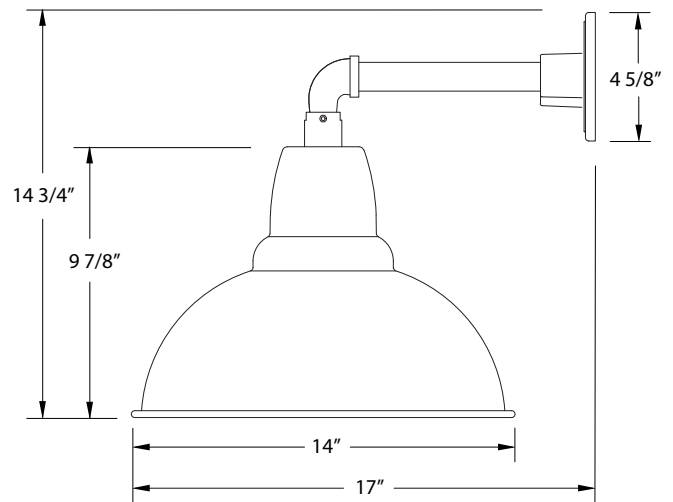

JOB/LOCATION

QUANTITY

DATE

NOTES